



# The Champion Family

High class in action. Safety you can rely on.

[www.boeckmann.com](http://www.boeckmann.com)



**FIRST CLASS TRANSPORT**





## High class.

For more than 65 years we have been designing horse trailers that are precisely tailored to the needs of horses and their riders, that meet the highest quality standards and offer a host of advantages in everyday equestrian life. Just like the Champion family. Reliable quality, robust materials and the Böckmann safety commitment make a noticeable difference. All features such as the chassis, aluminium side walls and tack locker in all Champion models are perfectly designed for daily use. Find out more about the latest generation of this track-proven horse trailer family. We hope you enjoy browsing through this brochure.

*Klaus Böckmann*

### Contents

The family company	4
The Champion family	6
Champion Uno C	8
Champion C and R	10
Big Champion SKA and E	12
Standard highlights	14
Room concepts	18
Model types	20
Tack lockers	22
Added value	26
Colours and decors	36
Accessories	38
Service	40
The Böckmann World	42





**From the idea to the product:** Anton Böckmann laid the foundations of the company with skilful craftsmanship and passion for his work.



**Unforgettable:** The four young Böckmann brothers on "Raudi", their first Shetland pony.



**Important hands-on experience** – Klaus Böckmann handling his own horses.



**Effective training means greater success** – Gilbert Böckmann at the stables of Böckmann Pferde GmbH.



**The next generation has now also joined the company's team:** Stella Böckmann and Justus Böckmann.



**One big family** – from a small blacksmith's workshop to the Böckmann Group – with a workforce of more than 500 in 2023.



The headquarters of Böckmann Fahrzeugwerke GmbH are located in Lastrup, Lower Saxony.

# Böckmann. The family company.

The company's development from a small village smithy to an international market leader has been shaped above all by one sentence: "You have to put your heart and soul into the business to be successful in the long term." This conviction, which Brigitte and Anton Böckmann have passed on to the family since the company was founded in 1956, still holds true today. With Stella Böckmann and Justus Böckmann the third generation of the company also stands for transport solutions which are characterised by first-class quality, the best design and absolute reliability. Another decisive part of the successful Böckmann DNA is also a matter close to the heart of the family members – their passion for equestrian sport. Looking after your own horses every day is both an inspiration and an opportunity to test vehicle developments. Only developments that have proven their worth are taken into production. This is how the company has been manufacturing horse trailers that deliver real added value for more than 65 years.



**The founders:** Anton († 2010) and Brigitte Böckmann († 2011).



# The Champion family.

The Champion family with an anodised aluminium superstructure is very robust, practical and durable. With the guiding principle "practical experience for practical applications", these trailers were specially developed for daily use. The standard highlights such as the Multi Safe System (MSS) safety stall bar system, the solid quality full aluminium floor and the tack locker concepts meet the highest demands of horse and rider. The unmistakable Böckmann design is impressive all along the line.

Take a look at the many extra benefits, the Böckmann safety guarantee and the equipment highlights and find out which Champion model is the right one for you.

**The Champion Family**

- Champion Uno C
- Champion C
- Champion Kutsche C
- Champion Western C
- Champion Pony 165 C
- Champion Isy 165 C
- Champion R
- Champion Western R
- Big Champion SKA
- Big Champion E



The Champion family, from left to right: Champion Uno C, Champion C, Champion R and Big Champion SKA.



# Champion Uno C.

The dimensions and the standard features of the Champion Uno C are especially designed for transporting a horse or mare with foal. The robust aluminium side walls, the full-length stall bars and the 1300 mm wide rear ramp with safety treads and side stops are just some of the extra advantages with impressive everyday benefits. The optionally available tack locker also provides an excellent space concept for optimum equipment storage.



**Ideal for transporting a horse or mare with foal**  
due to the optional space dimensions, quick access to the horse compartment and the optionally available tack locker with extensive standard features. For more information on the tack lockers turn to page 22.

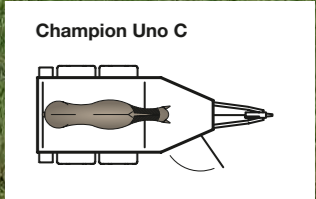



# Champion C and R.

With the particularly robust body made of anodised aluminium, the practical detailed solutions and the extensive equipment, the Champion C and the Champion R satisfy the highest demands. Extra advantages such as the solid quality full aluminium floor, the safety stall bar system (MSS), the kick protection and the lowered "CFFplus" comfort suspension chassis make these horse trailers perfect for daily use. In addition to the Champion C with a straight front wall, the Champion R has a polyester bow that enlarges the front area even more. The standard tack locker is perfectly coordinated and offers plenty of storage space for riding utensils and equipment. The tack locker for the Champion C is available as an option.



Champion C



Champion R

### Perfectly designed for daily use

due to the robust body with 1500 mm high side walls made of anodised aluminium, convenient access to the horse compartment as well as the standard tack locker on the Champion R with comprehensive features. For more information on the tack lockers turn to page 23.



Champion Western R

Champion C

The Champion C models are available in the additional versions Kutsche, Western, Pony and Islandic (Isy). The Champion R model is also available in the Western version (see page 20).

Champion Kutsche C    Champion Western C    Champion Pony 165 C    Champion Isy 165 C    Champion Western R

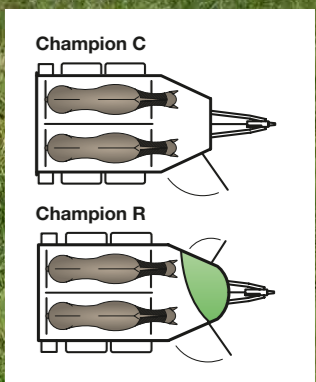



## **NEW** Big Champion SKA & E.

In the horse compartment, in the tack lockers, in daily use – the new Big Champion provides lots of space and comfort – and a high level of safety. With even more interior height and length, more space in front of the horses and in the tack lockers, extra high side walls (1700 mm) and man-high doors, this new generation of trailers is more practical than ever. The two models SKA (with a man-high entrance door and a tack locker accessible from inside and outside) and E (with 2 man-high entrance doors and a tack locker that is accessible from the interior) offer exclusive added benefits in daily use and an extensive range of standard features.



Big Champion SKA



Big Champion E

### Plenty of extra space for horses and riders

with the new space concepts of the E models (with 2 man-high entrance doors and a tack locker that is accessible from the interior) or SKA (with a man-high entrance door and a tack locker that is accessible from the inside and outside). For more information on the tack lockers turn to page 24.



Big Champion SKA

Big Champion E

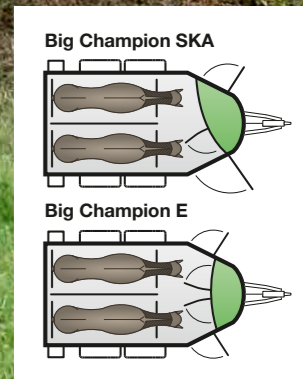



# Standard highlights.

The exclusive features such as the outstanding travelling comfort due to the World-Class "WCFplus" chassis to automotive standard, the large tack lockers with extensive features and the extra high side walls ensure comfort and safety as standard.



For descriptions of all standard advantages of the individual models and more visit: [www.boeckmann.com](http://www.boeckmann.com)



### Plenty of space and comfort

due to the easily accessible tack lockers with clever details and extensive standard accessories (optional on the Champion C and Champion Uno C). For more information on the tack lockers turn to page 22.



Champion Uno C



Champion C



Champion R



Big Champion E

### Safe transport

is ensured by the track-proven Böckmann partition wall system and the 10 cm safety stall bar system (MSS) with tie rings and an adjustable height range of 10 cm (chain version on the Champion Uno C, adjustable height and length). Further protection is provided by the additional stall bar padding as well as the padding and kick protection on the side walls.



MSS

### Fast safety in emergencies

with the track-proven Multi Safe System stall bar panic system (MSS) for front and rear (chain version on the Champion Uno C, adjustable height and length). The wheel spanner is included in the standard equipment.

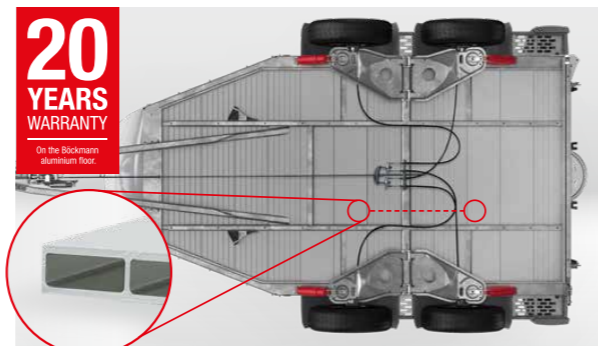

20 YEARS WARRANTY  
On the Böckmann aluminum floor

### Robust and rot-proof

due to the solid quality full aluminium floor with closed profile for reinforcement in the horse compartment.



Big Champion E



Champion C

### More space when loading and unloading

due to the wide entrance, the light and inviting interior and the cleverly designed partition wall system.

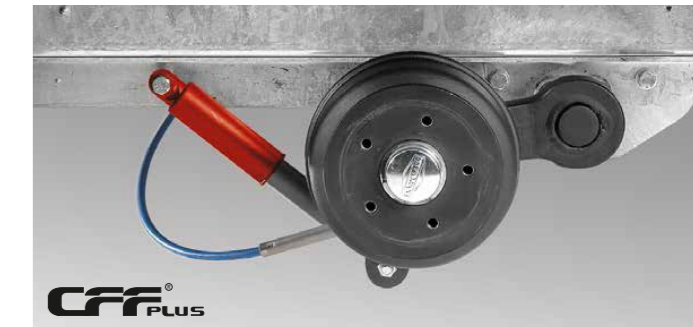

### Optimum road handling

due to the lowered comfort suspension chassis with wheel shock absorbers and soft suspension. Except for the Big Champion.

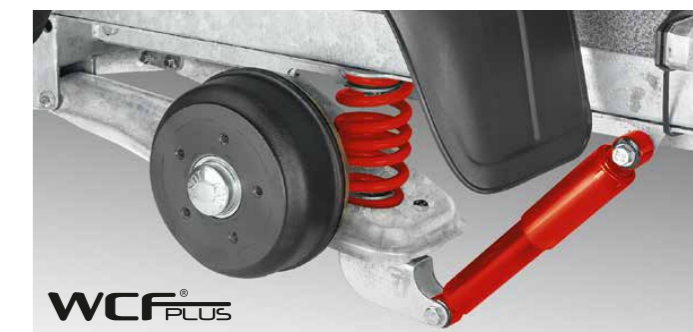

### Travelling comfort

with the World-Class chassis to automotive standards with wheel shock absorbers. Standard feature on the Big Champion.



### Simple operation

with the automatic jockey wheel – extra-long with easy-to-handle crank. Also easy to use in cold weather.



# Even more standard equipment.

The standard features of the Champion models already stand out with many details and innovations from which horse and rider benefit every day.



#### Comfortable standing position

due to the additional stall bar padding as well as the padding and kick protection on the side walls.



#### Safe hitching and unhitching

with the lockable cast coupling with rubberised, convenient heart-shaped handle and soft top (crash protection).



#### Many possible applications

with the rear ramp/door combination (standard feature on the Big Champion).



#### Good ventilation, light interior and sun protection

due to the pop-up side windows. Dazzle-free, with sunshade and safety grille.



#### Calming atmosphere

provided by the blue LED transport light – can be conveniently switched from blue to white.



#### Easily accessible feed

with two safety feeding troughs in an optimum position for the horses. Conveniently stowable in the tack locker (standard on the Big Champion).



#### Canvas lift

with integrated net and roll-up function.



#### Double web profile

with extra high side walls of 1500 mm or 1700 mm on the Big Champion models for safety and durability.

For descriptions of all standard advantages of the individual models and more visit:  
[www.boeckmann.com](http://www.boeckmann.com)





# The overview.



### Champion Uno C

Comfortable horse stall area with kick protection and side padding for a horse or mare with foal. Large entrance door to the horse compartment and optional tack locker accessible from the outside.

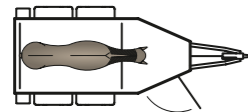

### Champion C

Comfortable horse stall area with kick protection, side padding and MSS for two horses. Large entrance door to the horse compartment and optional tack locker accessible from the outside.

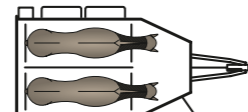

### Champion R

Aerodynamic design with the polyester bow with a tack locker as a standard feature. Comfortable horse stall area with kick protection, side padding and MSS for two horses.

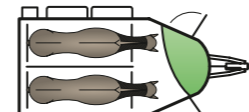

### Big Champion SKA

Large horse stall area with kick protection, side padding, MSS, Böckmann partition wall, lots of space in front of the horses, man-high entrance door and tack locker that is easily accessible from the inside and outside.

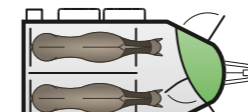

### Big Champion E

Large horse stall area with kick protection, side padding, MSS, Böckmann partition wall, even more space in front of the horses, two man-high entrance doors and a tack locker that can be easily accessed on both sides from the interior.

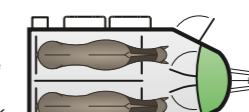

For descriptions of all standard advantages of the individual models and more visit: [www.boeckmann.com](http://www.boeckmann.com)





# The model types.

## Kutsche



Champion  
Kutsche C\*



### Lots of space for carriage equipment

with the tack locker equipped with pull-out saddle racks, plastic shovel, telescopic broom, mirror, door net and an interior light (accessory).



### Convenient carriage loading

with a carriage platform\* with solid corrugated aluminium sheets and drive-on rails; optionally with tube for stowing the whip.

## Western



Champion  
Western R



### Lots of space for riding equipment

in the tack locker with large saddle racks for Western saddles; equipped with plastic shovel, telescopic broom, mirror, door net, pad holder and interior lighting as a standard feature.



### Comfortable transport

due to the partition wall with optimised stall dimensions for medium-sized horses (height approx. 155 cm).

## Pony



Champion  
Pony 165 C



### Ideal for small horses

due to an interior height of 2120 mm; 2 feed troughs (accessories, included with optional tack locker) ensure easily accessible feed during the ride.



### Comfortable transport

due to the partition wall with optimised stall dimensions for small horses (height approx. 145 cm)

## Islandic



Champion  
Isy 165 C



### Lots of space for riding equipment

in the tack locker equipped with pull-out saddle racks, plastic shovel, telescopic broom, mirror, door net, pad holder and an interior light (accessory).



### Comfortable transport

due to the partition wall with optimised stall dimensions for Icelandic ponies (height up to approx. 145 cm); fencing systems can be stowed in the storage compartment at the side (standard feature).



## The tack locker. Champion Uno C.

The Champion Uno C tack locker is available as an option. The sophisticated design has a perfect space concept for maximum room and comfort.



Everything is conveniently accessible from the outside through the large tack locker door. Perfect closure with the 3-point door lock and rubber seal.



**Practical storage** with optimised cleaning and defined water drainage. The special shape with large radii does not have any edges for the horse to bite.



**Champion Uno C tack locker** accessible from the outside with a pull-out, padded and height-adjustable saddle rack, optimally positioned bridle hooks, riding crop holder, a plastic shovel, a telescopic broom, a mirror and a door net on the inside of the door, as well as a folding stool with safety catch and LED lighting.

## The tack lockers. Champion C and R.

While the Champion C with straight front wall can be equipped with a tack locker with accessories, the Champion R has a tack locker that is accessible from the outside as a standard feature and which provides a unique range of storage space and shelf areas due to the additional space of the polyester bow.



**Large shelf in the interior of the trailer** with incorporated recess.



Everything is conveniently accessible from the outside through the large tack locker door. Perfect closure with the 3-point door lock and rubber seal.



**Champion R tack locker** with storage compartment and extensive standard equipment: pull-out saddle racks, telescopic broom, plastic shovel, door net, mirror, riding crop holder, large bridle hooks and LED light.



# The tack lockers. Big Champion SKA and E.

The two different tack locker concepts enable an optimum layout that provides maximum storage space for equipment. The large doors make everything conveniently accessible and are designed to meet practical needs. Discover the extensive standard features and find out which model is the best transport solution for you – SKA or E.

**Practical shelf with optimised cleaning**  
with defined water drainage. The special shape with large radii does not have any edges for the horse to bite.



**Everything is conveniently accessible from inside and outside**

with the large tack locker doors, practical interior doors and rain gutter. Perfect closure with the 3-point door lock and rubber seal.



**Western tack locker (available as option)**

with large saddle racks for Western saddles; plastic shovel, telescopic broom, mirror, door net, pad holder and LED light provided as standard features (only Big Champion SKA).

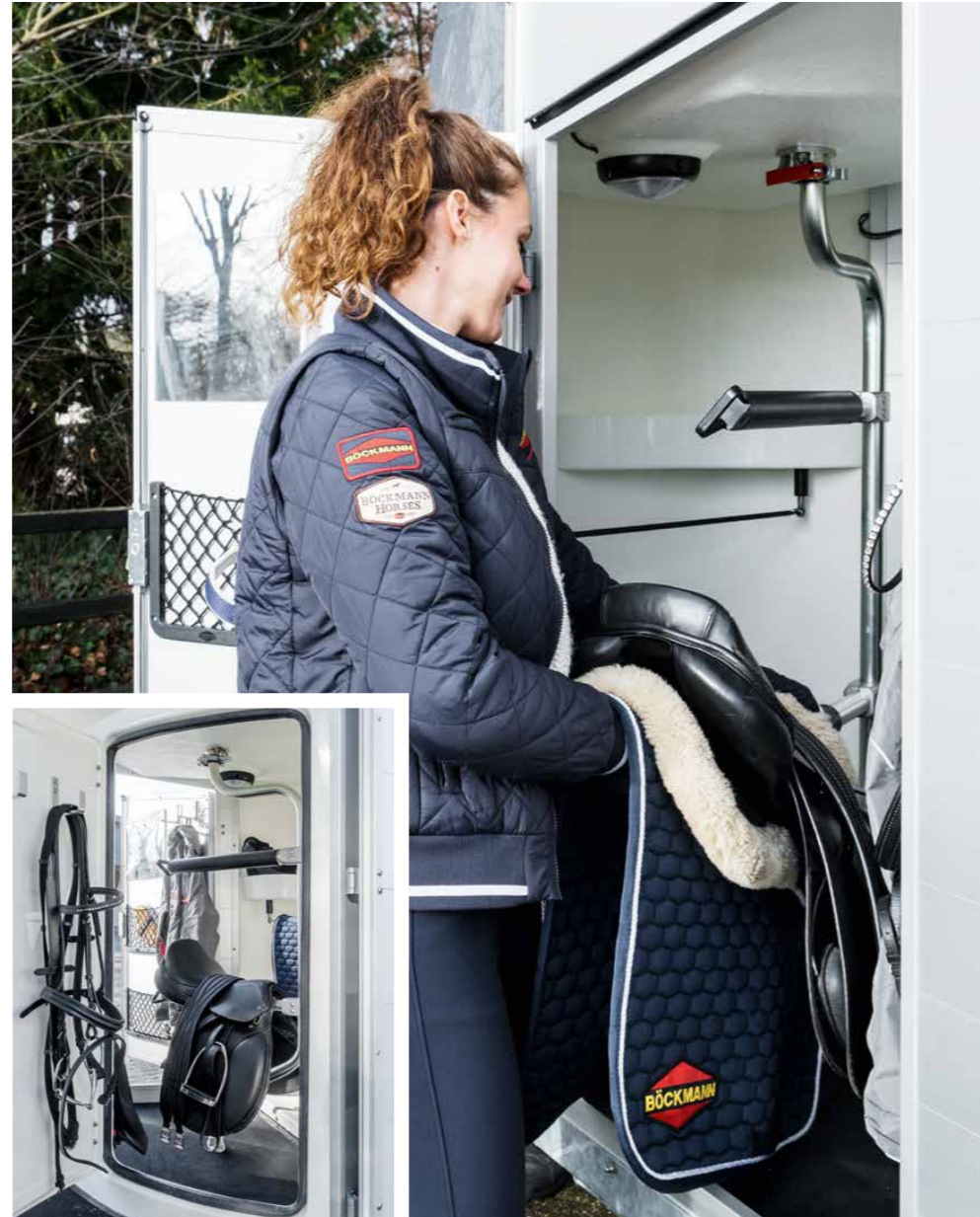

**Tack locker of the Big Champion SKA**

accessible from inside and outside with practical storage options such as two shelves. In addition to the horizontally and vertically adjustable as well as pull-out saddle rack, a telescopic broom, plastic shovel, door net, mirror, riding crop holder, feed troughs, large bridle hooks, pad holder, LED light and folding stool with safety catch are also included in the standard equipment.

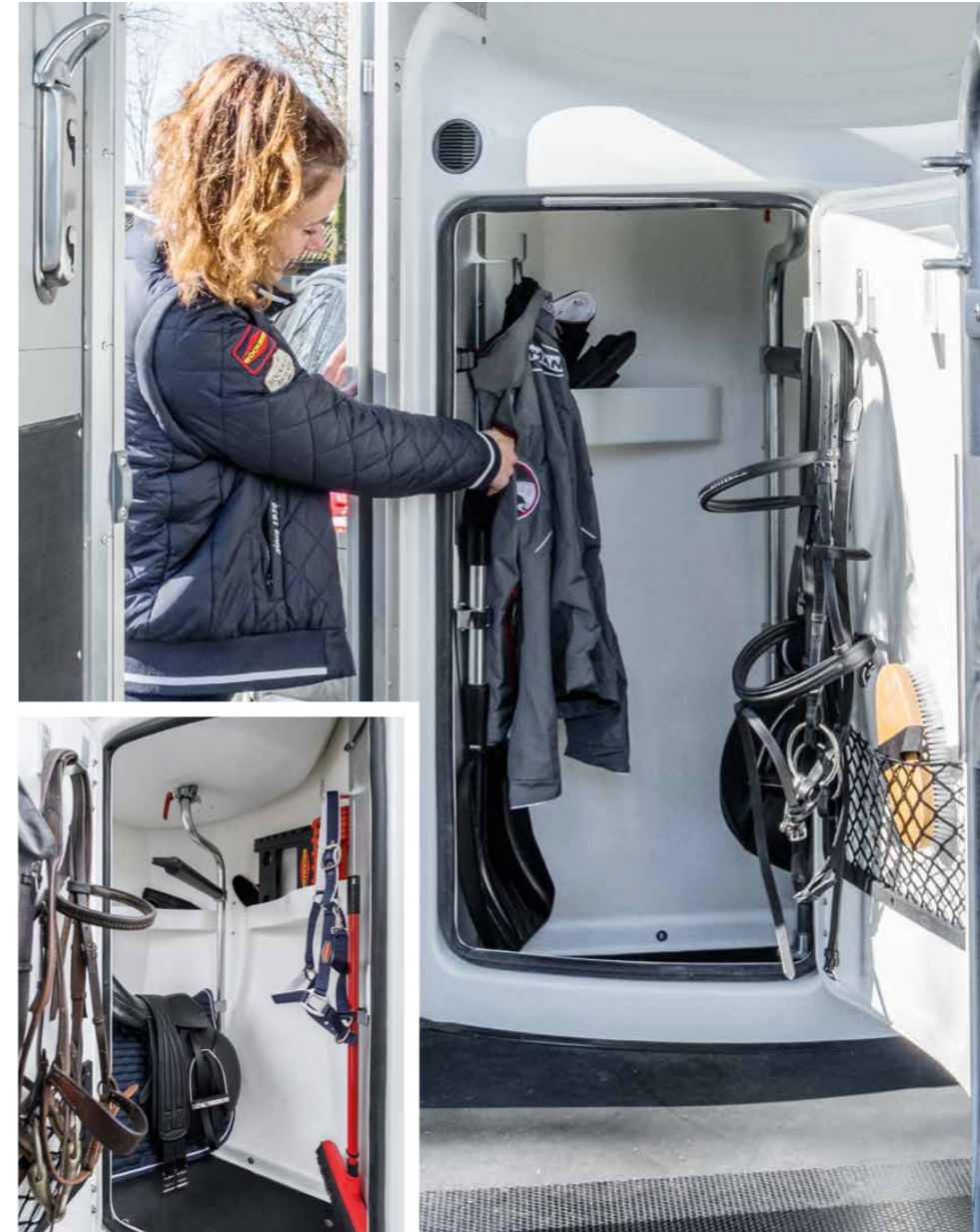

**Tack locker of the Big Champion E**

with two large doors, conveniently accessible from the inside and through the two man-high exterior doors. With practical storage options on the two shelves. In addition to the horizontally and vertically adjustable as well as pull-out saddle rack, standard features include a telescopic broom, plastic shovel, door net, mirror, riding crop holder, feed troughs, large bridle hooks, pad holder, LED light and folding stool with safety catch. Perfect closure with the 3-point door lock and rubber seal.





# Good for your horse.

The loading height, the light interior with plenty of headroom, the Multi Safe System (MSS) and the absolute absence of sharp corners and edges – the safety of your horses is our main priority. These detailed solutions – standard features on all Böckmann horse trailers – have been developed on the basis of 65 years of experience gained with our own horses and have been consistently adapted to their well-being and comfort.

For further details on the **Böckmann safety concept** and the added advantages visit [www.boeckmann.com](http://www.boeckmann.com)



## Large and inviting entrance

due to the narrow roof edges, interior canvas lift and the light interior walls. At night the interior lighting provides sufficient light in the interior.



## Low loading height

due to the lowered Comfort suspension chassis with wheel shock absorbers and soft suspension or the lowered World Class chassis with hot-dip galvanised independent suspension, coil spring suspension and wheel shock absorbers (the latter standard on the Big Champion).

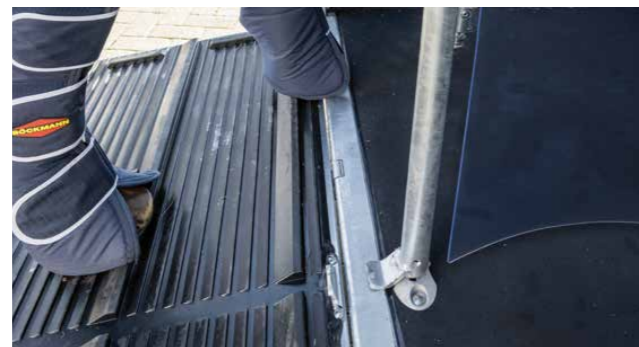

## Optimum foothold and minimised risk of slipping

due to special safety treads, side stops on the rear ramp covering and the narrow rear ramp hinge.



## Lots of room for a wide stance

due to securing of the PVC curtain 600 mm above the floor – for comfortable transport (except for Champion Uno).



Champion Uno C



Champion C

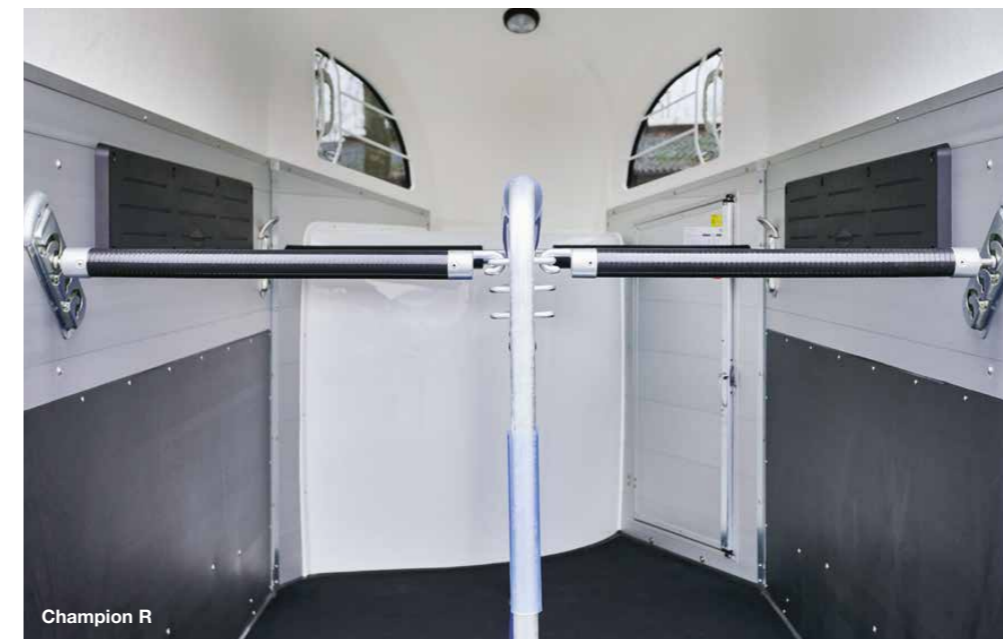

Champion R



Big Champion E

## Safe transport

is ensured by the track-proven Böckmann partition wall system and the safety stall bar system (MSS) with tie rings and an adjustable height range of 10 cm (chain version on the Champion Uno C). Further protection is provided by the additional stall bar padding as well as the padding and kick protection on the side walls.





**No slipping of the horse's hooves and good visibility from the car**  
due to closed, special perforated rear struts.



**Safe to stand on**  
due to the rubber floor with non-slip textile structure (wear mat available as an option).



**No sharp edges and corners**  
ensured by rounded hinges and plastic covers on the steel profile struts and at the ends of the rear struts.



**Plenty of room for the tail**  
due to the generous clearance between the stall bar and the rear ramp.



**Easily accessible feed**  
with two safety feeding troughs with holder (standard on Big Champion).



**Easily accessible hay**  
with optimally positioned hooks and counterholders for a hay net. The specially shaped tack locker with its large radii does not have any biting edges for the horse.



**Plenty of headroom, space and light interior**  
ensured by the generous space concepts of the Champion family. The tinted pop-up windows with integrated grille, large radii without corners and edges and flat hinges provide additional protection.



**Fast safety in emergencies**  
with the track-proven Multi Safe System stall bar panic system (MSS) for front and rear. The wheel spanner is included in the standard equipment. On the Champion Uno: Padded safety stall bar system with chain (adjustable height and length).



**Calming atmosphere**  
provided by the blue LED transport light – can be conveniently switched from blue to white.



**Safety**  
with the robust angle lever locks with 180° rotation that minimise the risk of injury to your horse.



**No entangling of the rope**  
due to flat door handles.



**Canvas lift**  
with integrated net and roll-up function.



**Good ventilation, light interior and sun protection**  
due to the pop-up side windows. Dazzle-free, with sunshade and safety grille.



# Good for you.

In addition to the needs of the horses, our horse trailers are tailored to the requirements of the riders. Innovations such as the chassis, the coupling and the automatic jockey wheel prove their worth in daily use.

Details such as the riding crop holder, the mounting step and the extra wide bridle hooks at the right place show that during development the main focus was on one main thing – practical experience for practical applications.



For further details on the extra advantages of the individual models visit:  
[www.boeckmann.com](http://www.boeckmann.com)



## Optimum closure

with the 3-point door lock and rubber seal.



## Safe hitching and unhitching

due to the lockable cast coupling with rubberised, convenient heart-shaped handle and soft top (crash protection).



## Plenty of space for loading and unloading

due to the large clearance between the stall bar and tack locker in the front area of the trailer.



## Easy manoeuvring

due to the automatic jockey wheel – extra-long with an easy-to-handle crank and optimally positioned manoeuvring handle, perfect to use, even in cold weather.



## Quick access to the horse compartment

for example through a man-high entrance door and plenty of space once inside.



## Crash and theft protection

provided by the lockable cast-iron coupling with soft-top crash protection and rubberised, convenient heart-shaped handle.



## Convenient carriage loading

with a new carriage retainer with solid corrugated aluminium sheets and drive-on rails; optionally with tube for stowing the whip.



## Unimpeded access to the car boot

due to the rubberised, convenient heart-shaped coupling handle and the flat brake lever – also when attached.



## Comfortable transport

for Icelandic horses due to the partition wall with optimised stall dimensions (height up to approx. 145 cm).



## Convenient operation

due to the easily accessible and separate light switch for the interior lighting on the right-hand entrance door.



## One key for all locks

with a master key in triplicate for the tack locker door, entrance door and cast coupling.

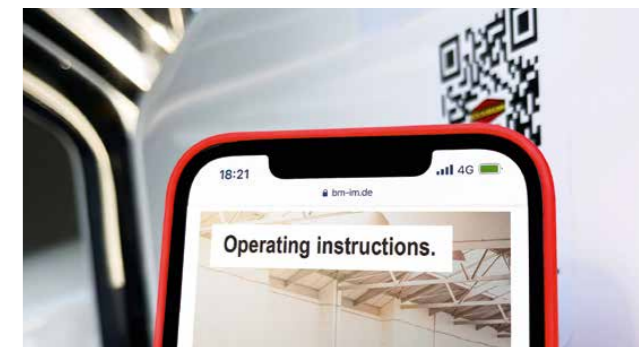

## Fast access to the operating instructions

with the QR code directly on the vehicle.





#### Tack locker as a shelf

with an optimised design and plenty of space and no biting edge for the horses. Practical cleaning with defined water drainage.

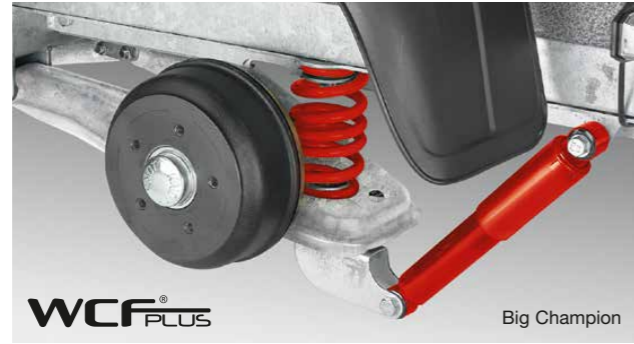

#### Travelling comfort

with the World-Class chassis to automotive standards with wheel shock absorbers.

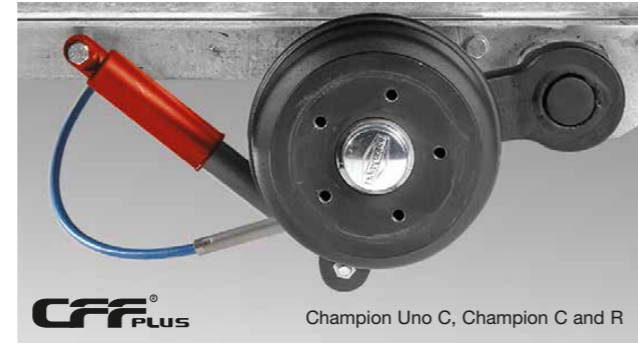

#### Optimum road handling

with the lowered comfort suspension chassis with wheel shock absorbers and soft suspension.



#### Practical protection against damage

with door catches on the doors.



#### Protection from rain

provided by the rain gutters above the doors and also in the rear area.



#### More travelling safety

due to the large-dimensioned quality tyres. Alu rims available as an accessory.



#### Fenders as shelf

with the wide and open, straight form of the impact-resistant plastic or polyester fenders (accessory).



#### Easy to tow

due to the aerodynamic body and low centre of gravity.



#### Simple operation

due to the practical roll-up function of the canvas lift. Lifting device for easy opening of the rear ramp, additionally with robust double step.



#### Convenient operation and extensive standard features in the tack locker

with a door catch as well as a telescopic broom, plastic shovel, door net, mirror, riding crop holder, feed troughs, large bridle hooks, pad holder, LED light and folding stool with safety catch (features depend on the selected model).



#### Tie options

with lots of fittings on and in the trailer.



# Good for lasting value.

Original Böckmann quality down to the last detail – for you this means: Durability and a high resale value. This is achieved by absolutely solid workmanship and the use of high-quality materials. Experience the strength and safety of our horse trailers yourself.



For further details on the extra advantages of the individual models visit: [www.boeckmann.com](http://www.boeckmann.com)

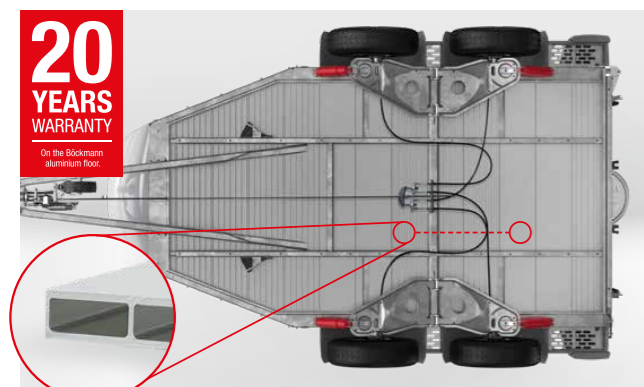

**20 YEARS WARRANTY**  
On the Böckmann aluminium floor.  
**Robust, rot-proof and made for high loads**  
due to the solid quality full aluminium floor with closed profile for reinforcement in the horse compartment as well as the longitudinal beam construction and the welded, hot-dip galvanised steel frame.



**Strong frame**  
with a full-length Z-profile frame of galvanised special steel – firmly bolted to the body.



**Resilient**  
due to the fully bonded and sealed rubber floor (8 mm) throughout.

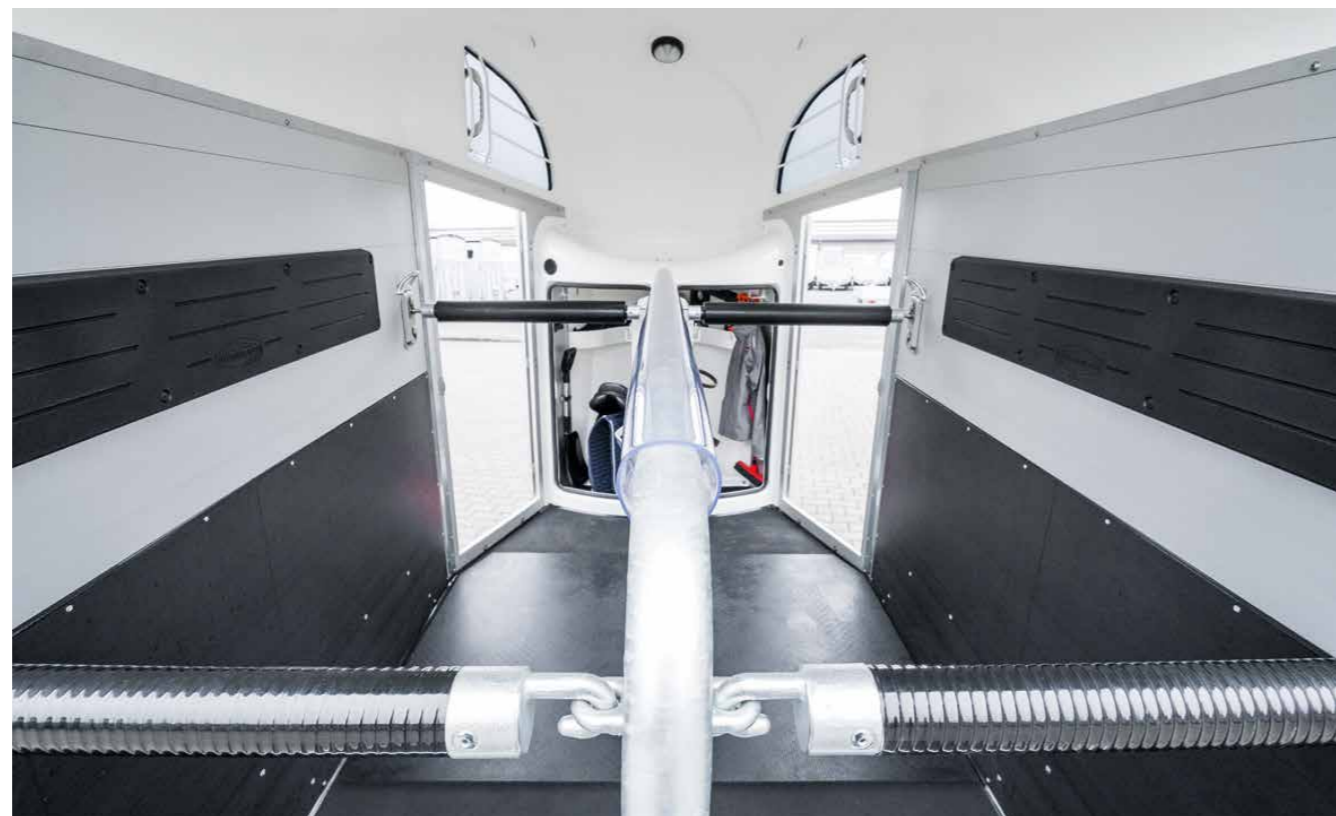

**Kick protection**  
with a particularly impact-resistant plastic on the side walls and in front of the horse (only possible in the Champion Uno C and the Big Champion SKA).



**Robust rear ramp**  
with four galvanised steel profile struts (3 struts on the Champion Uno C) with integrated lifting device; additionally with new, robust double step.



**Strong partition wall construction and high-quality materials**  
due to the solid, welded steel frame.



**Anodised aluminium double web profile**  
for outstanding durability.



**Higher payload**  
with a total weight of 2400 kg as standard instead of 2000 kg for the Big Champion (Champion Uno C: 1600 kg total weight, Champion Pony 165 C and Champion Isy 165 C: 2000 kg, Champion Kutsche C: 2700 kg).



# Great design.

Individuality in its most appealing form – all Champion models can be designed according to your taste. Many colour combinations are possible – from the roof to the body to the covers for side braces. We would also be pleased to offer you individual and photorealistic lettering according to your specifications. Simply ask the Böckmann specialist dealer in your area.



The Big Champion SKA in the colour anthracite metallic<sup>2</sup>, the Champion C in the colour green metallic<sup>2</sup> and the Champion Uno C in deep orange<sup>3</sup>.



White<sup>2</sup>



Silver metallic<sup>1</sup>



Anthracite metallic<sup>2</sup>



Slate grey<sup>3</sup>



Silver grey<sup>3</sup>



Dark blue metallic<sup>2</sup>



Red metallic<sup>2</sup>



Green metallic<sup>2</sup>



Dark brown metallic<sup>2</sup>



Royal blue<sup>3</sup>



Flame red<sup>3</sup>



Magenta<sup>3</sup>



Yellow<sup>3</sup>



Yellow green<sup>3</sup>



Deep orange<sup>3</sup>

<sup>1</sup> Standard <sup>2</sup> Without surcharge <sup>3</sup> With surcharge

Experience has shown that printing inks cannot reproduce the original colour of paintwork. We therefore recommend that you ask your Böckmann partner to show you the colour samples. Individual colour combinations, special finishes as well as letterings based on your design are possible. Your Böckmann specialist dealer will be pleased to help you.

# Great outlook.

Create "your Böckmann" according to your personal preferences. Large or small decor, multi-colour or monochrome – the choice is yours. The decors are exclusively designed by Jan Künster for Böckmann. We would be pleased to create custom decors and custom sizes based on your design upon request. Your Böckmann partner would be pleased to help you.



**Small decor**  
Positioning example of small decor motif "Mare with foal".



**Large decor**  
Positioning example of large decor motif "Competition, greyscale".

All decors are available in anthracite as a standard feature. Additional decor colours available on request.



Strong trot, multi-colour

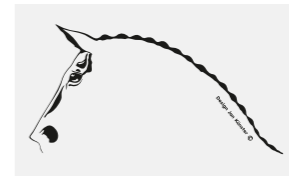

Horse's head

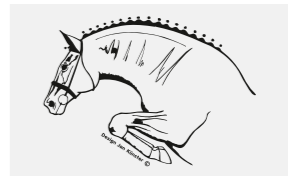

Jumper

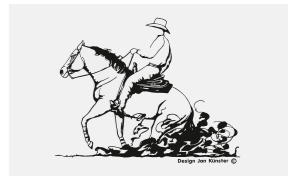

Western

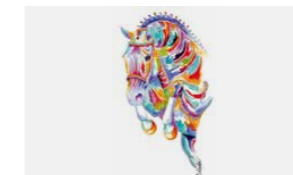

Jumper, multi-colour



Gaited horse



Arabian

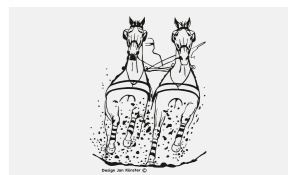

Driving sport

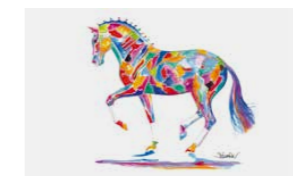

Piaffe, multi-colour

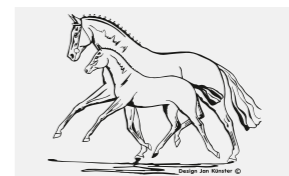

Mare with foal

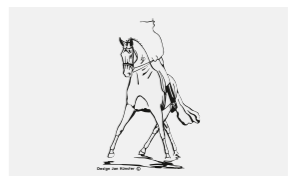

Dressage

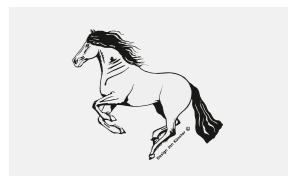

Frisian

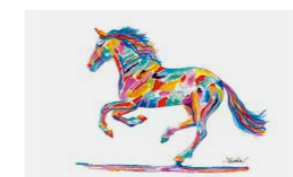

Gallop, multi-colour

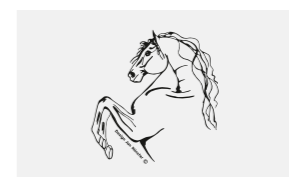

Andalusian



Military



Artline



Competition, multi-colour

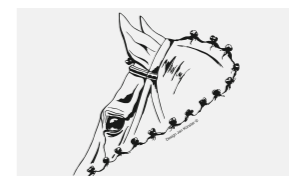

Competition

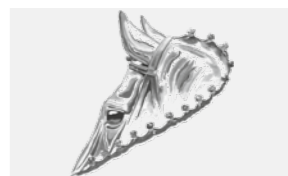

Competition, greyscale



# Accessories.

The range of standard features of the Champion family is extensive. The models have many details and innovations from which both horse and rider benefit. Even more is possible with the original Böckmann accessories – customise your Champion horse trailer to suit your needs and those of your horses.



Discover the full range of accessories and configure your Champion online:  
[www.boeckmann.com/en/configurator](http://www.boeckmann.com/en/configurator)



Champion Uno C

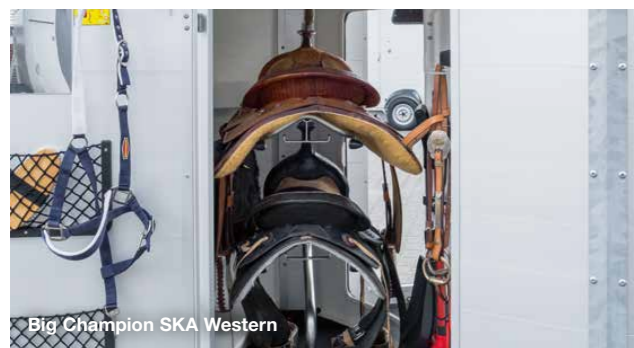

Big Champion SKA Western

**Everything perfectly stowed**  
with various tack locker options with extensive standard features. Depending on the model also available with Western equipment.



**Safety on the road**  
with a folding foal grid.



**Easy mounting**  
with the climbing aid that can be easily unfolded on the rear ramp; this also puts less strain on the horse's back.



**Practical storage option**  
with a tie up bar for saddle and saddle pad (on the side of the trailer).



**Safe transport**  
due to the aluminium head divider wall e.g. for transporting two stallions.

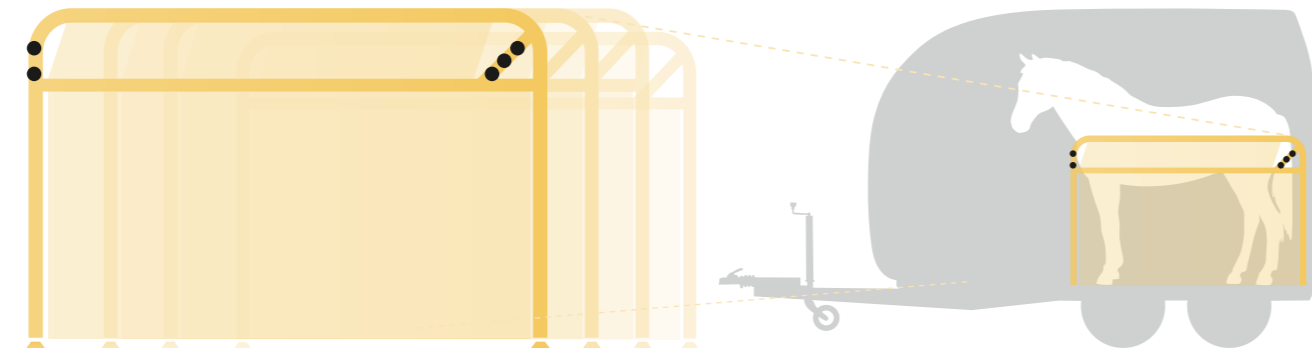

**Comfortable transport for horses of all sizes**  
with the partition wall concept. You can equip your horse trailer with a partition wall that perfectly suits your horse upon request.



**Optimum ventilation**  
with the roof vent in the polyester roof.



**Several safety features**  
such as the anti-torsion coupling [1] (up to 2.7 t total weight, not lockable), the weatherproof protective cover [2] and the spare wheel with spare wheel holder and a spare wheel cover [3].



**More light at the rear**  
with the additional interior light.



**Visual highlight**  
with the polyester covers for side braces, the single polyester fenders as well as the Böckmann Premium aluminium rims.



**Everything in view**  
with the video surveillance of the horse compartment as well as an additional rear view camera.



**Durability**  
with the kick protection in front of the horses [1] (only possible with the Big Champion SKA or the Champion Uno C with tack locker) and the wear mat in the front leg area [2].



## First class service.

As a Böckmann customer you will receive personal support with many service offers directly on site. Our dense network of competent and trained Böckmann sales partners is at your disposal worldwide. They will be able to provide you with the excellent trailer advice and top-notch service you need. We have put together more information and tips for you in our online service portal:



### Original part orders

Guaranteed exact fit, reliability, durability in daily use and a higher resale value. Original Böckmann parts can be purchased from your local dealer.

[www.boeckmann.com/en/accessories](http://www.boeckmann.com/en/accessories)



### Repair service

Trained employees take care of all repairs and the installation of original parts if necessary. Also together with the next general inspection upon request.

[www.boeckmann.com/en/services](http://www.boeckmann.com/en/services)



### Böckmann magazine

Read our Böckmann magazine for important information, trade fair dates and helpful trailer tips. Take a look inside:

[www.boeckmann.com/en/magazine/magazin](http://www.boeckmann.com/en/magazine/magazin)



### Böckmann FAQs

Frequently asked questions about transport, trucks and trailers. We support you with answers so that you are perfectly prepared for your transport task.

[www.boeckmann.com/en/services/faqs](http://www.boeckmann.com/en/services/faqs)

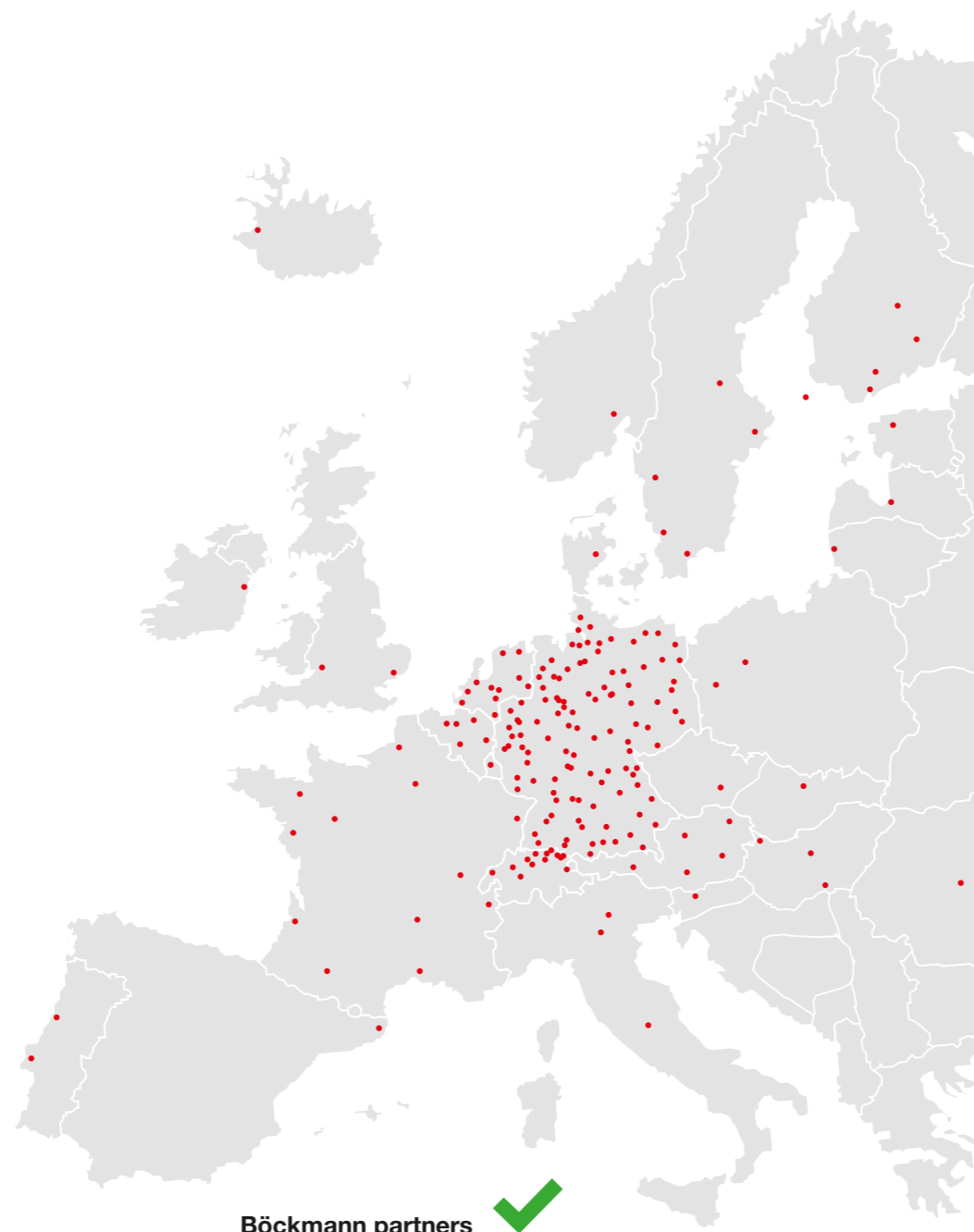

### Böckmann partners

Find your personal Böckmann specialist dealer at home and abroad with ease. Refer to our specialist dealer locator at:

[www.boeckmann.com/en/dealer-locator](http://www.boeckmann.com/en/dealer-locator)

## Böckmann financing options.

Would you like to finance or lease a new Champion? Simply contact your local specialist dealer and ask about the various options. Your Böckmann specialist dealer will be happy to help you.

Ask your local dealer!



Trailers shown may include special accessories.



# Get moving with Böckmann. First class and hand in hand.

The Böckmann brand has stood for progress, quality and reliability since 1956. Our services and products are designed to inspire people time and time again and deliver real added value. "You have to put your heart and soul into the business to be successful in the long term" was the guiding principle of our founders. And this is still a living part of the company today and every day. Welcome to the world of Böckmann.



## Böckmann trailers

A success story which started in 1956: As the trailers are used for Böckmann's own horses, they have been subjected to constant improvement over the years. In this way we became the international market leader for horse trailers.



## Böckmann horses

Everything for your horses. Everything from one source. Everything in Hamstrup! Ranging from horse-friendly accommodation with individual care to foaling and successful training in dressage and show jumping by the renowned trainer Gilbert Böckmann and his team.



## Böckmann transporters

Thanks to the experience of over 65 years of equestrian sport, we develop horse trucks that leave nothing to be desired. Whether in the living or sleeping compartment or the horse compartment – every single detail is designed and produced individually in Lastrup. And naturally hand-crafted. Let us advise you directly at the Truck Center.



## Böckmann Collection

From sweat rugs to polo shirts to folding rules – discover the entire Böckmann Collection. Simply scan the QR code and explore the entire range.



Find out more about Böckmann:





























f [facebook.com/anhangsterklasse](https://facebook.com/anhangsterklasse)

▶ [boeckmann.com/youtube](https://boeckmann.com/youtube)

@ [instagram.com/boeckmann.horses](https://instagram.com/boeckmann.horses)



# Technical data

									
 <b>Champion Uno C</b>	1600 kg	2730 mm	1830 mm	4490 mm	2300 mm	1300 mm	3100 mm	840 kg	
 <b>Champion C</b>	2400 kg	2730 mm	2200 mm	4500 mm	2300 mm	1650 mm	3100 mm	1502 kg	
 <b>Champion Pony 165 C</b>	2000 kg	2550 mm	2200 mm	4500 mm	2120 mm	1650 mm	3100 mm	1160 kg	
 <b>Champion Isy 165 C</b>	2000 kg	2550 mm	2200 mm	4500 mm	2120 mm	1650 mm	3100 mm	1160 kg	
 <b>Champion Western C</b>	2400 kg	2730 mm	2200 mm	4500 mm	2300 mm	1650 mm	3100 mm	1502 kg	
 <b>Champion Kutsche C</b>	2700 kg	2730 mm	2200 mm	5885 mm	2300 mm	1650 mm	3050 mm	1630 kg	
 <b>Champion R</b>	2400 kg	2730 mm	2200 mm	4500 mm	2300 mm	1650 mm	3280 mm	1497 kg	
 <b>Champion Western R</b>	2400 kg	2730 mm	2200 mm	4500 mm	2300 mm	1650 mm	3280 mm	1497 kg	
 <b>Big Champion SKA</b>	2400 kg	2755 mm	2301 mm	4726 mm	2350 mm	1750 mm	3560 mm	1367 kg	
 <b>Big Champion E</b>	2400 kg	2755 mm	2301 mm	4726 mm	2350 mm	1750 mm	3560 mm	1385 kg	

Changes to design and equipment reserved. Weights and dimensions approximate and may change due to additional equipment. Some illustrations in this brochure do not show standard equipment.

Your Böckmann specialist dealer for consulting and service:

Böckmann Fahrzeugwerke GmbH 49688 Lastrup

Phone +49 (0) 4472 895-0

info@boeckmann.com www.boeckmann.com

f facebook.com/anhangensterklasse ▶ boeckmann.com/youtube

@ instagram.com/boeckmann.horses



**FIRST CLASS TRANSPORT**