



The Traveller family

More options. More space.

www.boeckmann.com



FIRST CLASS TRANSPORT



Outstandingly functional.

For more than 65 years we have been designing horse trailers that are precisely tailored to the needs of horses and their riders, that meet the highest quality standards and offer a host of advantages in everyday equestrian life.

Simply give your horse more: More options. More space. And more loading comfort. The Traveller family is ideal for both professional and amateur riders who would like to take several horses with them on their trips. Thanks to the design of the Traveller family, the horses can be transported standing diagonally, which offers them more comfort on their journey. The striking design and many practical features are also impressive. We hope you enjoy browsing through this brochure and finding out more about our range.

Klaus Böckmann

Contents

The family company	4
The Traveller family	6
Traveller K	8
Traveller W	10
Traveller G	12
Standard features	14
Room concepts	18
Tack lockers	20
Added value	22
Colours and decors	28
Accessories	30
Service	32
The Böckmann World	34

1st place in the "Horse trailers" category
Böckmann has been voted the favourite brand in the horse trailer category more than five times in a row.





From the idea to the product: Anton Böckmann laid the foundations of the company with skilful craftsmanship and passion for his work.



Unforgettable: The four young Böckmann brothers on "Raudi", their first Shetland pony.



Important hands-on experience: Klaus Böckmann handling his own horses.



Effective training means greater success: Trainer Gilbert Böckmann.



The next generation has now also joined the company's team: Stella Böckmann and Justus Böckmann.



One big family: From a small blacksmith's workshop to the Böckmann Group – with a workforce of more than 500 in 2024.

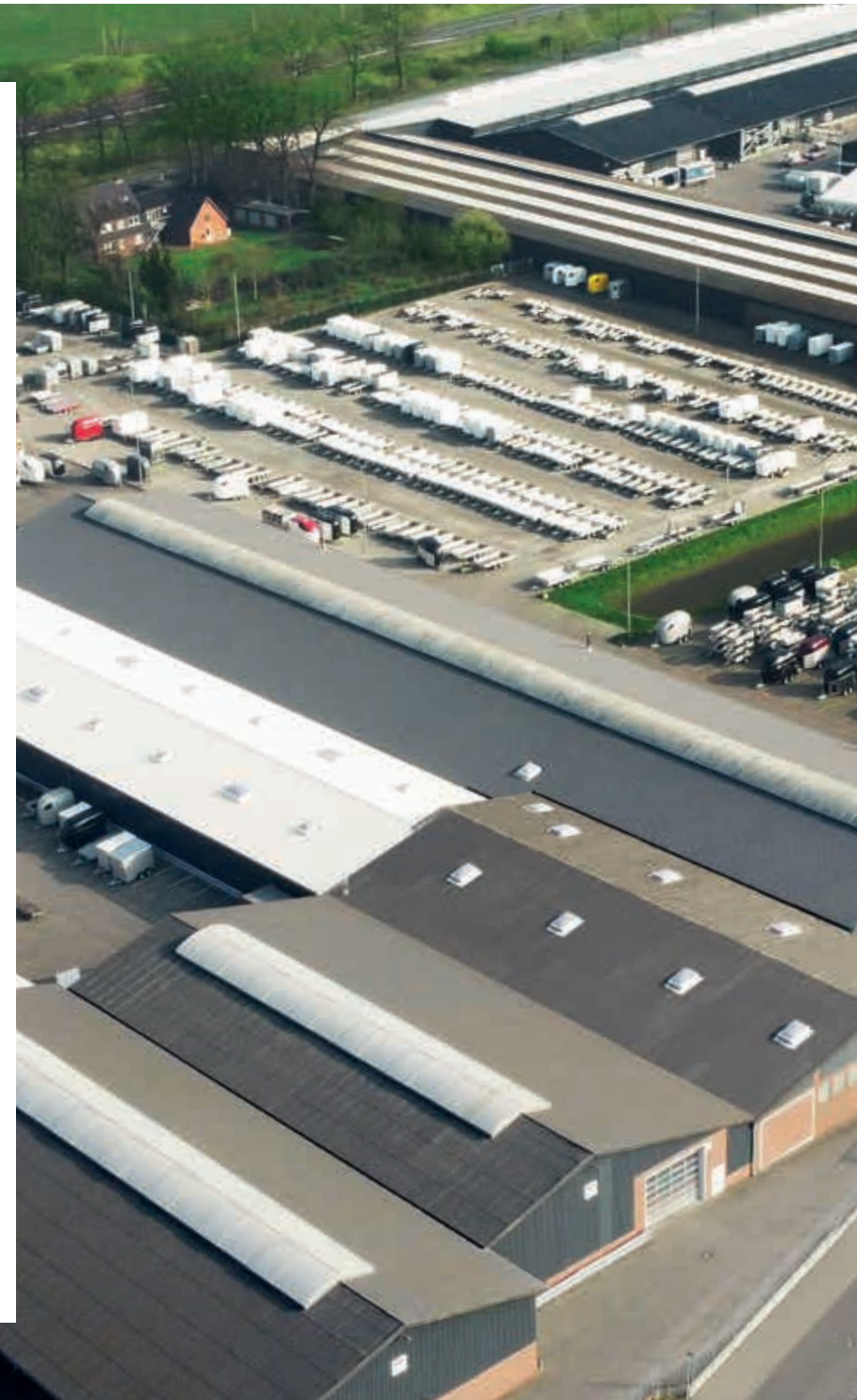

Böckmann. The family company.

The company's development from a small village smithy to an international market leader has been shaped above all by one sentence: "You have to put your heart and soul into the business to be successful in the long term." This conviction, which Brigitte and Anton Böckmann have passed on to the family since the company was founded in 1956, still holds true today. With Stella Böckmann and Justus Böckmann, the third generation of the company also stands for transport solutions which are characterised by first-class quality, the best design and absolute reliability.

Another decisive part of the successful Böckmann DNA is also a matter close to the heart of the family members – their passion for equestrian sport. Looking after your own horses every day is both an inspiration and an opportunity to test vehicle developments. Only developments that have proven their worth are taken into production. This is how the company has been manufacturing horse trailers that deliver real added value for more than 65 years.



The founders: Anton († 2010) and Brigitte Böckmann († 2011).



The headquarters of Böckmann Fahrzeugwerke GmbH are located in Lastrup, Lower Saxony.

The Traveller family.

Depending on the model, the Traveller family offers enough space for two to three large horses, three to four Western horses or up to five small horses. The design allows the horses to be transported standing diagonally, which offers them more comfort when travelling. The striking design and practical details make the Traveller family a versatile option for various disciplines.

Take a look at the numerous extra benefits, the Böckmann safety commitment and the highlights. Find out which Traveller model is right for you.

The Traveller family

For small horses with a height of up to approx. 145 cm



Traveller K3

 (max. 3 horses)

Traveller K3 Big SK

 (max. 3 horses)

Traveller K4

 (max. 4 horses)



Traveller K4 Big SK

 (max. 4 horses)

Traveller K5

 (max. 5 horses)

For medium-sized horses with a height of up to approx. 155 cm



Traveller W2 Big SK

 (max. 2 horses)



Traveller W3

 (max. 3 horses)



Traveller W3 Big SK

 (max. 3 horses)

Traveller W4

 (max. 4 horses)

For large horses with a height of up to approx. 165 cm



Traveller G2

 (max. 2 horses)

Traveller G3

 (max. 3 horses)



The illustration shows the Traveller W3 Big SK, Traveller K3 Big SK and Traveller G3 (from left to right) with accessories



Experience the new Bockmann
Traveller models –
scan the code now!



Traveller K

Specially engineered for small horses with a height of up to approximately 145 cm and their riders, the Traveller K has an impressively compact and manoeuvrable design. The K models have lots of space for up to five small horses. The impressive list of practical features makes handling child's play and guarantees both optimum comfort and maximum safety for your horses.



Traveller K3 Big SK



Traveller K4

In the Traveller K models, a hinged aluminium partition wall separates the tack locker from the horse compartment. Telescopic divider bars ensure safe transport. In the walk-in tack locker, hinged saddle racks are mounted in the sloping area. The Big SK models have swivelling Western saddle holders.



The illustration shows the Traveller K3 Big SK with accessories



Traveller K3



Traveller K3 Big SK

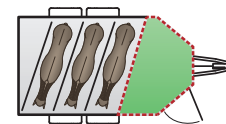

Traveller K4

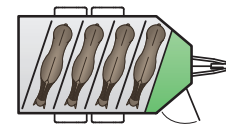

Traveller K4 Big SK

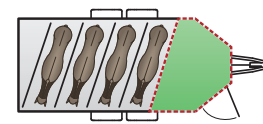

Traveller K5

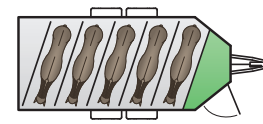

Traveller W

If you have Western horses, Arabs or polo horses with a height of up to approx. 155 cm, the Traveller W guarantees a first class trip for three or even four horses. The four different Traveller W models have an impressive range of features including the tack locker, large saddle racks as well as a diagonal loading system and are also extremely robust with the all-round steel bar.



The illustration shows the Traveller W3 Big SK with accessories

The Traveller W models have a fixed partition wall to the tack locker in which a door for direct access to the horse compartment can be fitted (accessory). In the horse compartment, laterally adjustable and swivelling aluminium partition walls with PVC curtains ensure safe transport. The walk-in tack locker has swivelling professional saddle racks.



Traveller W2 Big SK

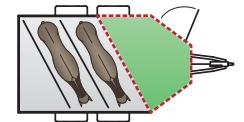

Traveller W3

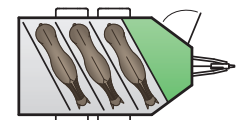

Traveller W3 Big SK

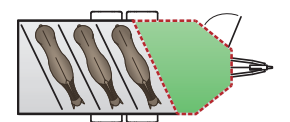

Traveller W4

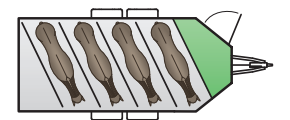

Traveller G

Double and triple benefits: With the Traveller G you can transport two or three horses with a height of up to 165 cm at once, depending on the model. Thanks to the design of the Traveller family, the horses can be transported standing diagonally, which offers them more comfort while travelling. The very robust G models with their all-round steel bar are equipped with telescopic aluminium partition walls with a PVC curtain that can be adjusted at the side.



The Traveller G models have a fixed partition wall to the walk-in tack locker, in which a door for direct access from the horse compartment can be installed (accessory). Adjustable and swivelling aluminium partition walls with PVC curtains are fitted in the horse compartment. The walk-in tack locker is equipped with extendable and adjustable saddle racks.



The illustration shows the Traveller G3 with accessories



Traveller G2

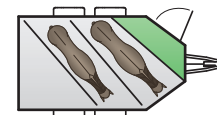

Traveller G3

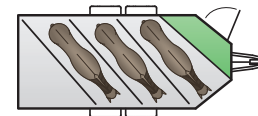

Standard highlights.

The exclusive range of features offers outstanding travelling comfort thanks to the "CFFplus" comfort suspension chassis. The walk-in tack locker has an extensive range of equipment and the extra high side walls provide additional stability: Comfort and safety guaranteed.



Easy access

through the full-height door. The tack locker is equipped with a plastic bucket and telescopic broom as well as mirror on the tack locker door and door net as standard features.



Traveller K3 Big SK



Traveller K3 Big SK



Traveller G3



Traveller G3

Safe transport

with the track-proven Böckmann partition wall systems: The Traveller K is equipped with telescopic divider bars. The Traveller W and Traveller G models have laterally adjustable and swivelling aluminium partition walls with PVC curtains. The kick protection on the left-hand side wall provides extra stability.

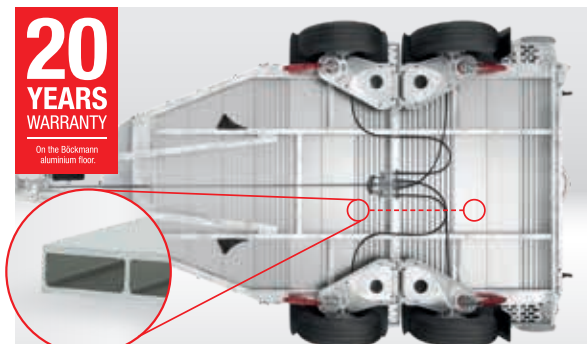

20 YEARS WARRANTY
On the Böckmann aluminium floor.

Robust and rot-proof

due to the solid quality full aluminium floor with closed profile for reinforcement in the horse compartment.

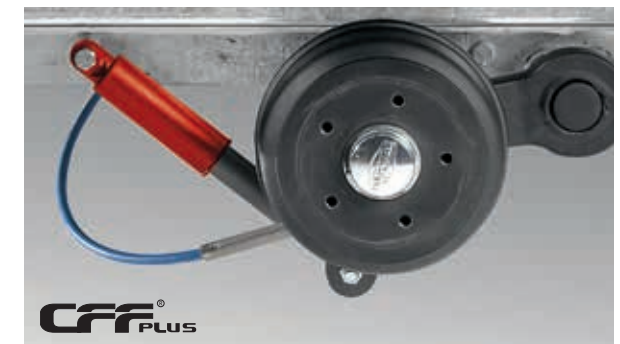

CFF PLUS

Optimum road handling

with the lowered comfort suspension chassis with wheel shock absorbers and soft suspension. 100 km/h requirement (only applies to Germany).



Plenty of space and comfort

due to the tack lockers with clever details and extensive standard accessories (for more information about the tack lockers turn to page 20).



Safe entry

due to the rubber surface on the rear ramp with security treads and side stops.



Traveller K3 Big SK



Traveller W3 Big SK

Traveller G2

Easy loading and unloading

due to the diagonal loading system with either adjustable telescopic divider bars (Traveller K), which can be quickly and easily moved to the side, or laterally adjustable aluminium partition walls with PVC curtains (Traveller W and Traveller G).

Even more standard equipment.



Robust rear ramp

with four galvanised steel profile struts with integrated lifting device for easy opening of the rear ramp, additionally with new double step.



Comfortable standing position

due to the inclined position, which allows the horses to balance themselves particularly well.



Safe hitching and unhitching

with the lockable cast coupling with rubberised, convenient heart-shaped handle and soft top (crash protection).



Good ventilation, light interior and sun protection

thanks to several side windows that can be opened horizontally with sun protection and safety grille near the horse's head. Large sliding windows with grilles are only available on the Traveller W and G models.



Calming atmosphere

provided by the blue LED transport light – can be conveniently switched from blue to white.



Easily accessible feed

with safety feeding troughs in an optimum position for the horses. Conveniently stowable in the tack locker.



Many possible applications
with the removable bars.



Tarpaulin lift
with automatic retraction function [1] and integrated net [2].



Robust structure made of anodised aluminium double web profile
for safety and durability.



Simple operation
even in cold weather with the heavy-duty automatic jockey wheel (standard on the K4 Big SK, K5, W3 Big SK, W4 and G3) or the automatic jockey wheel, extra-long with handy plastic crank handle.

For further details on the standard features of the individual models visit:
www.boeckmann.com



Plenty of room. And freedom of choice.

In the Traveller horse trailer family, the decision is yours:
How many horses do you want to transport? How big should the tack locker be – spacious or generously dimensioned (Big SK)? Choose the Traveller version that suits you best from the five basic sizes.



H 2100 x W 2000 x L 3170
(internal dimensions in mm)

H 2100 x W 2000 x L 3570
(internal dimensions in mm)

H 2100 x W 2000 x L 4580
(internal dimensions in mm)

H 2400 x W 2000 x L 3570
(internal dimensions in mm)

H 2400 x W 2000 x L 4580
(internal dimensions in mm)

Traveller K3

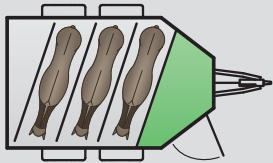

Traveller K3 Big SK

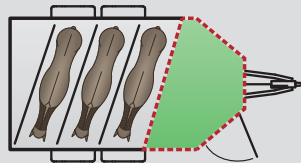

Traveller K4 Big SK

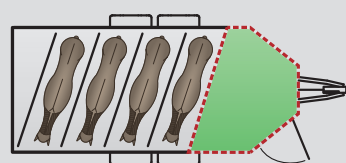

Traveller W2 Big SK

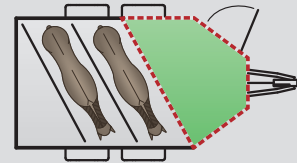

Traveller W3 Big SK

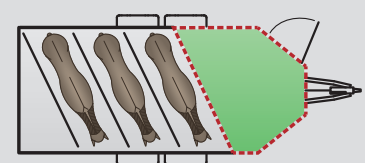

Traveller K4

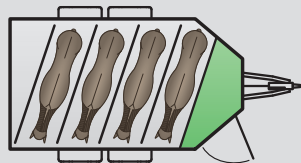

Traveller K5

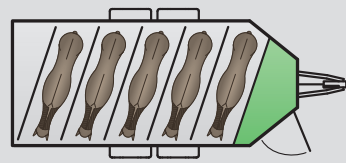

Traveller W3

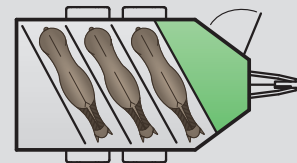

Traveller W4

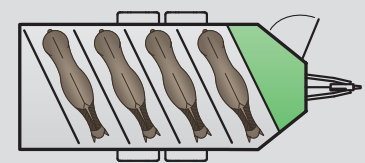

Traveller G2

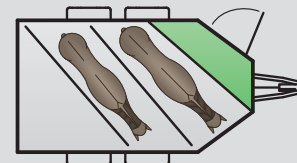

Traveller G3

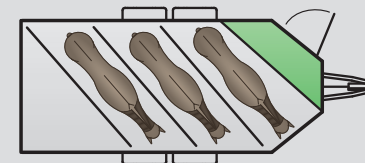

Traveller K for small horses, Traveller W for Western horses, Traveller G for large horses



Traveller K3



Traveller K3 Big SK

Tack locker comparison "SK vs. Big SK":

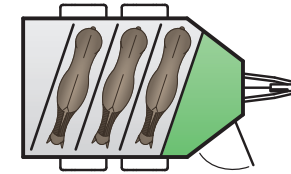

Traveller K3 with a length of 3170 mm

Large horse compartment for up to three horses with hinged partition wall to the walk-in tack locker.

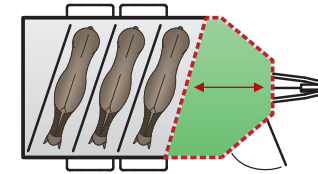

Traveller K3 Big SK with a length of 3570 mm

Large horse compartment, similar to the K3, for up to three horses with hinged partition wall to the walk-in tack locker with additional space.



Traveller W3 Big SK



Traveller W4

Tack locker – spacious or generously dimensioned?

All tack lockers have a wide range of accessories and are well-dimensioned. For additional comfort and extra space, we recommend the spacious, walk-in tack lockers of the Traveller Big SK. We have summarised details of the basic features for you on the following pages. Find out which tack locker is right for you.

Tack lockers. Basic features.

Snaffle hooks exactly where you need them. Saddle racks that are easy to use and storage space such as shelves, nets and riding crop holder that are simply practical. In addition, all models have extensive standard equipment. Take a look at the overview of our highlights.

Practical storage options
with numerous snaffle hooks.



Traveller K3 Big SK

Optimum closure
with the 3-point door lock and rubber seal.



Traveller G3

Traveller K3 Big SK

Practical storage options
with large shelves.



Traveller K3



Traveller K3 Big SK

Wide range of standard features

In addition to the horizontally and vertically adjustable as well as pull-out saddle rack or professional saddle rack, a telescopic broom, plastic shovel, door net, mirror, riding crop holder, feed troughs, large snaffle hooks and LED light are also included in the standard features (the quantity depends on the model).



Traveller G3

Optimum configuration

for maximum storage space e.g. with pull-out saddle rack, shelves and door net.



Traveller W3 Big SK



Traveller W4

The Western equipment

is characterised by the professional saddle racks with a wide support surface, which makes them ideal for the safe transport of the larger Western saddles. They are already included in the standard features of all Traveller Big SK models.



LED lighting

conveniently switched on and off.



Protection from rain

provided by the rain guttering above the tack locker door.

Good for your horse.

The loading height, the large and inviting entrance as well as the different partition wall systems for safe transport – the safety of your horses is our main priority. These detailed solutions – standard features on all Böckmann horse trailers of the Traveller family – have been developed on the basis of 65 years of experience gained with our own horses and have been consistently adapted to their well-being and comfort.

For further details on the **Böckmann safety concept** and the added advantages visit www.boeckmann.com



Traveller K3

Large and inviting entrance

due to the narrow roof edges, interior tarpaulin lift and the bright, white interior walls. At night the interior lighting provides sufficient light inside.



Traveller G3

Low loading height

with the lowered comfort suspension chassis with wheel shock absorbers and soft suspension. 100 km/h requirement (only applies to Germany).

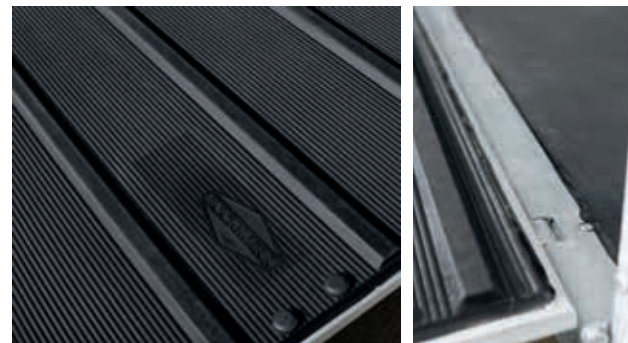

Optimum foothold and minimised risk of slipping

due to special safety treads, side stops on the rear ramp surface and the enclosed, narrow rear ramp hinge.



Calming atmosphere

provided by the blue LED transport light – can be conveniently switched from blue to white.



Traveller K4

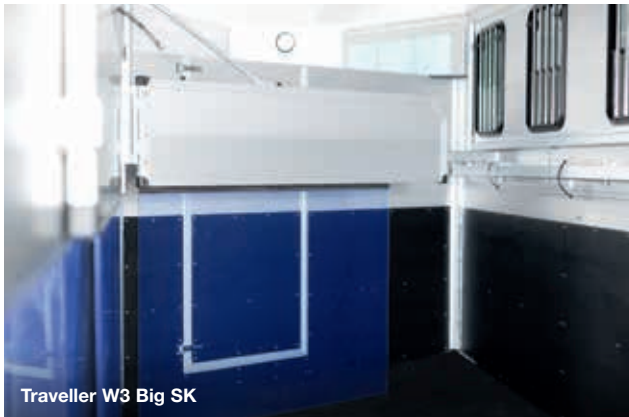

Traveller W3 Big SK



Traveller G2 with accessories

Safe transport

with the telescopic divider bars (Traveller K) or the aluminium partition walls with PVC curtains (Traveller W and Traveller G). The kick protection on the left-hand side wall provides additional stability.



Traveller G3

Plenty of headroom, space and light interior

ensured by the generous space concepts of the Traveller family. The side sliding windows with integrated grille, large radii without corners and edges and flat hinges provide additional protection.



Safety

with the robust, angle lever locks with 180° rotation that minimise the risk of injury to your horse.



No entangling of the rope

due to flat door handles.

Good for you.

In addition to the needs of the horses, our horse trailers are tailored to the requirements of the riders.

Innovations such as the chassis, the coupling, the jockey wheel as well as the crash and theft protection prove their worth in daily use. Details such as the crop holder, the mounting step and the extra wide snaffle hooks at the right place show that during development the main focus was on one main thing – practical experience for practical applications.

For further details on the extra advantages visit www.boeckmann.com

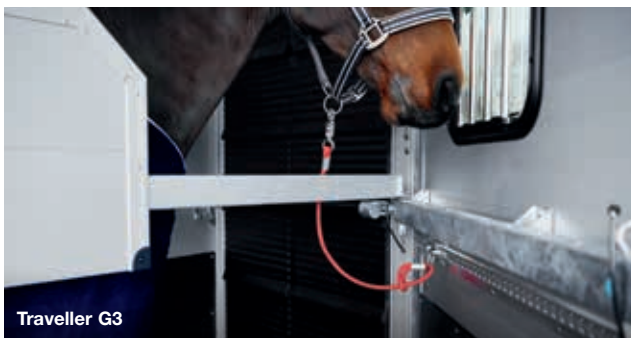

Traveller G3

Tie options

with lots of fittings on and in the trailer (some accessories).

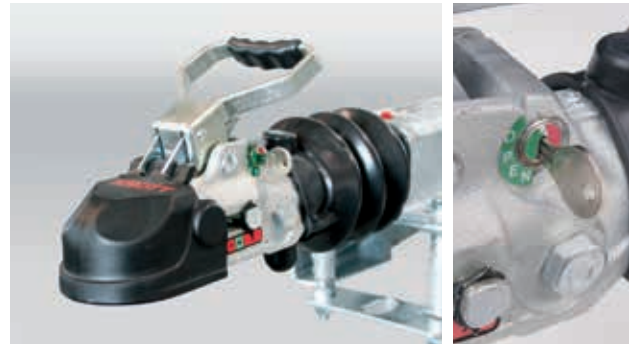

Safe hitching and unhitching

due to the lockable cast coupling with rubberised, convenient heart-shaped handle and soft top (crash protection). One key for all locks.



Traveller G3

Plenty of space for loading and unloading

thanks to the sliding aluminium partition walls with PVC curtains (Traveller W and Traveller G) or telescopic divider bars (Traveller K).



Simple operation

with the heavy-duty automatic jockey wheel (standard on the K4 Big SK, K5, W3 Big SK, W4 and G3) or by the automatic jockey wheel.



Traveller G3

Simple operation

due to the practical retraction function of the tarpaulin lift. Lifting device for easy opening of the rear ramp, additionally with robust double step.



Traveller K3 Big SK

More travelling safety

due to the large quality tyres (aluminium rims are accessories).



Unimpeded access to the car boot

due to the rubberised, convenient heart-shaped coupling handle and the flat brake lever – also when attached.



Protection from rain

provided by the rain gutters above the doors and also in the rear area.



Traveller G3

Quick access to the horse compartment

through a large entrance door and plenty of space once inside (standard on the Traveller K).



Traveller K3 Big SK

Easy to tow

due to the aerodynamic body and low centre of gravity – also saves fuel.



Excellent view on the road

due to closed, specially perforated rear struts.

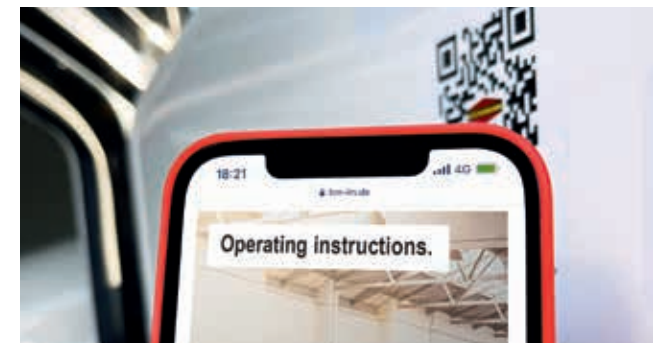

Fast access to the operating instructions

with the QR code directly on the vehicle.

Good for stable value.

Original Böckmann quality down to the last detail – for you this means: Durability and an excellent trade-in value. This is achieved by absolutely solid workmanship and the use of high-quality materials. Experience the strength and safety of our horse trailers yourself.

For further details on the extra advantages visit www.boeckmann.com



Practical protection against damage
with door catches on the doors.

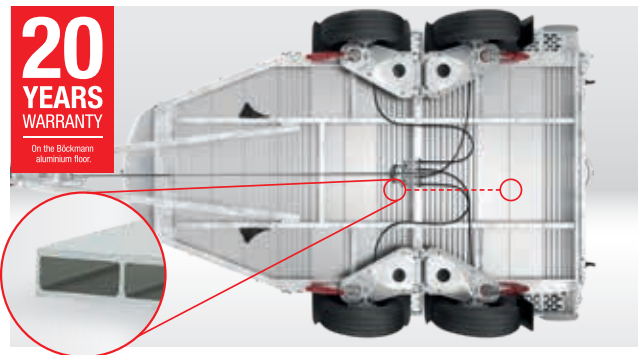

Robust, rot-proof and made for high loads

due to the solid quality full aluminium floor with closed profile for reinforcement in the horse compartment as well as the longitudinal beam construction and the welded, hot-dip galvanised steel frame.



Strong frame

with a full-length Z-profile frame of galvanised special steel – firmly bolted to the superstructure.



Resilient

due to the fully bonded and sealed rubber floor (8 mm) throughout.



Traveller K3 Big SK

Kick protection

with a particularly impact-resistant plastic on the side walls and in front of the horse (kick protection on the right is an accessory).



Strong partition wall construction and high-quality materials with the telescopic divider bars (Traveller K) or the aluminium partition walls with PVC curtains (Traveller W and Traveller G).



Robust rear ramp with four galvanised steel profile struts with integrated lifting device; additionally with robust double step.



Anodised aluminium double web profile for outstanding durability.



Sufficient payload with the standard 2400 kg for the Traveller K3, 2700 kg for the Traveller K3 Big SK, K4, W2 Big SK, W3, G2 and 3500 kg for the Traveller K4 Big SK, K5, W3 Big SK, W4, G3.

Great design.

Individuality in its most appealing form – all Traveller models can be customised to your taste by choosing the colour of the roof. We would also be pleased to offer you individual and photorealistic lettering according to your specifications. Simply ask the Böckmann specialist dealer in your area.

White²Silver metallic¹Anthracite metallic²Slate grey³Silver grey³Dark blue metallic²Red metallic²Green metallic²Dark brown metallic²Slate grey metallic³Royal blue³Flame red³Magenta³Yellow³Yellow green³Deep orange³Frozen berry³

The Traveller K3 with polyester roof in yellow-green³.



The Traveller W3 Big SK with polyester roof in dark blue metallic².

¹ Standard ² Without surcharge ³ With surcharge

Experience has shown that printing inks cannot reproduce the original colour of paintwork. We therefore recommend that you ask your Böckmann partner to show you the colour samples. Individual colour combinations, special finishes as well as letterings based on your design are possible. Your Böckmann specialist dealer will be pleased to help you.

Great looks.

Create "your Böckmann" according to your personal preferences. Small decors – multi-coloured or monochrome: the choice is yours. The decors are exclusively designed by Jan Künster for Böckmann. We would be pleased to create custom decors and custom sizes based on your design upon request. Your Böckmann partner would be pleased to help you.



Small decors

Positioning example of the small "Horse's head" decal motif.

Customisation

with individual letterings and decors for your Traveller (accessories). Contact us!



Strong trot, multi-colour

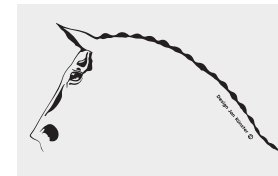

Horse's head

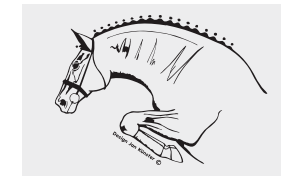

Jumper



Western



Jumper, multi-colour

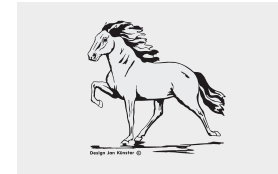

Gaited horse



Arabian



Harnessed horses



Piaffe, multi-colour

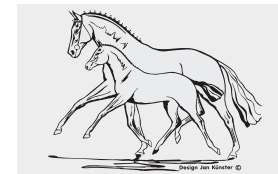

Mare with foal



Dressage



Frisian



Gallop, multi-colour

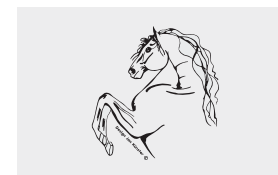

Andalusian

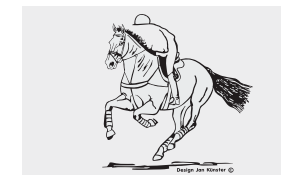

Military

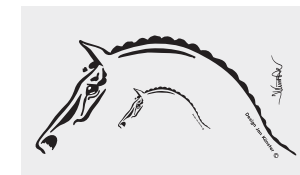

Artline

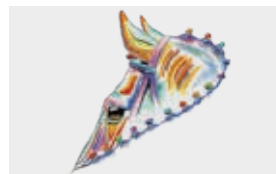

Competition, multi-colour



Competition



Tournament, greyscale

Accessories.

The range of standard features of the Traveller family is extensive. The models have many details and innovations from which both horse and rider benefit. Even more is possible with the original Böckmann accessories – customise your Traveller to suit your needs and those of your horses.



Head divider

For example for transporting two stallions, ensuring a safe journey.



Side flap

with integrated sliding windows and gas struts as well as a step.



Wide, extra-long unloading ramp

with rubber surface and “shock absorber” lifting device (only for Traveller G).



Double wing door

With espagnolette lock at rear and two sliding windows instead of a rear ramp.



Aluminium wheel rims

as a visual highlight.



Extra weight

up to 2700 kg (Traveller K3) or 3000 kg (Traveller K3 Big SK and Traveller K4) total weight possible for a sufficient payload.



Retractable awning

for sun protection.



Clever ceiling storage

with greater distance to the roof (1), edge protection (2) and a load arrester (3) as a large storage option.



Additional interior light

for more light at the rear.



Video surveillance

of the horse compartment and an additional reversing camera allow you to keep an eye on everything.



Several safety features

such as the anti-torsion coupling [1] (up to 2.7 t total weight, not lockable), the weatherproof protective hood [2] and the spare wheel with spare wheel holder and a spare wheel cover [3].

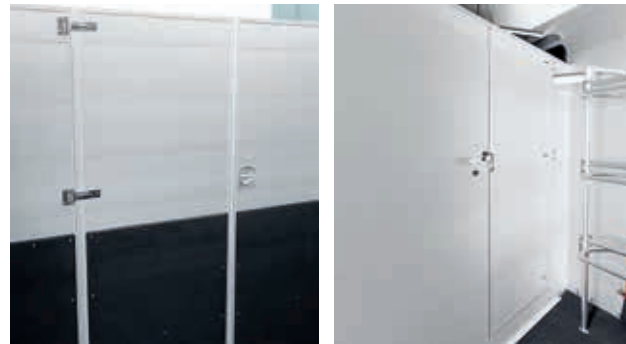

Door in the partition wall to the tack locker

(only for Traveller W and G) for faster access. A slip-through door is optional for the Traveller K Big SK models.



Airline bar and tie chains

for safe transport.

Additional accessories

- Supports at rear
- Additional tying up rings
- External spot at left (front or rear)
- Additional vent on polyester roof
- Third brake light in polyester roof
- Heavy-duty automatic jockey wheel (standard on the K4 Big SK, K5, W3 Big SK, W4 and G3)
- Additional sliding window
- 2 sockets 230V in storage compartment with circuit breaker
- Generator (230 V, 1850 W)
- Kick protection (plastic) on right side wall (on left as standard feature)
- Periphery lighting for reversing
- Wear mat
- RoFlex fencing system (Traveller K models)

First class service.

As a Böckmann customer you will receive personal support with many service offers directly on site. Our dense network of competent and trained Böckmann sales partners is at your disposal around the world. They will be able to provide you with the excellent trailer advice and top-notch service you need. We have put together more information and tips for you in our online service portal:



Original part orders

Guaranteed exact fit, reliability, durability in daily use and a higher resale value. You are welcome to purchase Böckmann original parts from your specialist dealer in your region.

www.boeckmann.com/en/accessories



Repair service

Trained employees take care of all repairs and the installation of original parts if necessary. Also together with the next general inspection upon request.

www.boeckmann.com/en/services



Böckmann magazine

Read our Böckmann magazine for important information, trade fair dates and helpful trailer tips. Take a look inside:

www.boeckmann.com/en/magazine



Böckmann FAQs

Frequently asked questions about transport, trucks and trailers. We provide answers to your questions and the support you need to be perfectly prepared for your transport needs.

www.boeckmann.com/en/services/faqs



Böckmann partners

Find your personal Böckmann dealer at home and abroad quickly and easily. Refer to our dealer locator at:

www.boeckmann.com/en/dealer-locator

Böckmann financing options.

Ask your
local dealer!

Would you like to finance or lease a new Traveller? Simply contact your local dealer and ask about the various options. Your Böckmann dealer will be happy to help you.



Trailers shown include special accessories in some cases.

Get moving with Böckmann. First class and hand in hand.

The Böckmann brand has stood for progress, quality and reliability since 1956. Our services and products are designed to inspire people time and time again and deliver real added value. "You have to put your heart and soul into the business to be successful in the long term" was the guiding principle of our founders. And this is still a living part of the company today and every day. Welcome to the world of Böckmann.



Böckmann trailers

A success story which started in 1956: As the trailers are used for Böckmann's own horses, they have been subjected to constant improvement over the years. In this way we became the international market leader for horse trailers.



Böckmann horses

Everything for your horses. Everything from one source. Everything in Hamstrup! Ranging from horse-friendly accommodation with individual care to foaling and successful training in dressage and show jumping by the renowned trainer Gilbert Böckmann and his team.



Böckmann transporters

Thanks to the experience of over 65 years of equestrian sport, we develop horse trucks that leave nothing to be desired. Whether in the living or sleeping compartment or the horse compartment – every single detail is designed and produced individually in Lastrup. And naturally hand-crafted. Let us advise you directly at the Truck Center.



Böckmann Shop

Spare parts and accessories, collection and merchandise in original Böckmann quality directly from the manufacturer. Simply scan the QR code and explore the entire range in the online shop.





Find out more about Böckmann:

f facebook.com/anhangensterklasse





▶ boeckmann.com/youtube

© instagram.com/boeckmann.horses





Technical data





For small horses with a height of up to approx. 145 cm

	Traveller K3	2400 kg/2700 kg*	2490 mm	2550 mm	4615 mm	2100 mm	2000 mm	3170 mm	1225 kg/1525 kg*	1175 kg	 (max. 3 horses)
	Traveller K3 Big SK	2700 kg/3000 kg*	2490 mm	2550 mm	5015 mm	2100 mm	2000 mm	3570 mm	1480 kg/1780 kg*	1220 kg	 (max. 3 horses)
	Traveller K4	2700 kg/3000 kg*	2490 mm	2550 mm	5015 mm	2100 mm	2000 mm	3570 mm	1480 kg/1780 kg*	1220 kg	 (max. 4 horses)
	Traveller K4 Big SK	3500 kg	2510 mm	2540 mm	5705 mm	2100 mm	2000 mm	4580 mm	1880 kg	1620 kg	 (max. 4 horses)
	Traveller K5	3500 kg	2510 mm	2540 mm	5705 mm	2100 mm	2000 mm	4580 mm	1880 kg	1620 kg	 (max. 5 horses)

For medium-sized horses with a height of up to approx. 155 cm

	Traveller W2 Big SK	2700 kg	2790 mm	2550 mm	5015 mm	2400 mm	2000 mm	3570 mm	1405 kg	1295 kg	 (max. 2 horses)
	Traveller W3	2700 kg	2790 mm	2550 mm	5015 mm	2400 mm	2000 mm	3570 mm	1405 kg	1295 kg	 (max. 3 horses)
	Traveller W3 Big SK	3500 kg	2810 mm	2540 mm	5705 mm	2400 mm	2000 mm	4580 mm	1880 kg	1620 kg	 (max. 3 horses)
	Traveller W4	3500 kg	2810 mm	2540 mm	5705 mm	2400 mm	2000 mm	4580 mm	1880 kg	1620 kg	 (max. 4 horses)

For large horses with a height of up to approx. 165 cm

	Traveller G2	2700 kg	2790 mm	2550 mm	5015 mm	2400 mm	2000 mm	3570 mm	1405 kg	1295 kg	 (max. 2 horses)
	Traveller G3	3500 kg	2810 mm	2540 mm	5705 mm	2400 mm	2000 mm	4580 mm	1830 kg	1670 kg	 (max. 3 horses)

Changes to design and equipment reserved. Weights and dimensions are approximate and may change due to added features. Some illustrations in this brochure do not show standard equipment. *Accessories

Your Böckmann specialist dealer for consulting and service:

Böckmann Fahrzeugwerke GmbH 49688 Lastrup

Phone +49 (0) 4472 895-0

info@boeckmann.com www.boeckmann.com

f facebook.com/anhangensterklasse ▶ boeckmann.com/youtube

@ instagram.com/boeckmann.horses



FIRST CLASS TRANSPORT